



Barrio Munegazo 22
01400 Llodio (Alava)
Tel. 946719710
comercial@vidrala.com

BG 37,5 CL

Product characteristics

Code	1005/242
Capacity	375 ml
Finish	CETIE
Colours	
Weight	300 gr
Overall height	240.50 mm
Diameter	64.10 mm
Palet	2.576 units

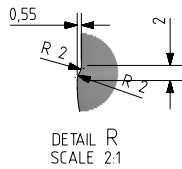
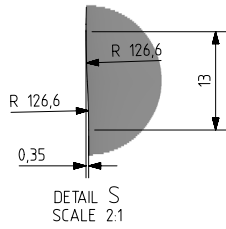
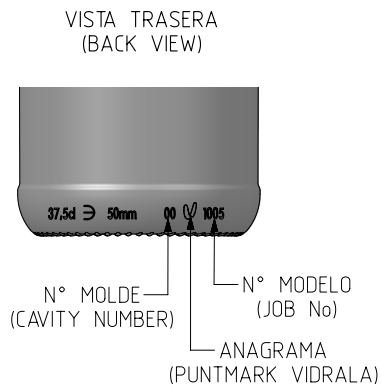

ZONA DE GRABADOS / HEEL EMBOSING
(Opuesto al código de ptos / Opposite to dot code)



VISTA FRONTAL
(FRONT VIEW)

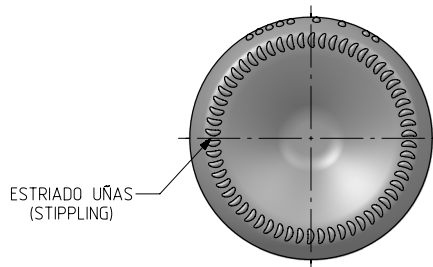
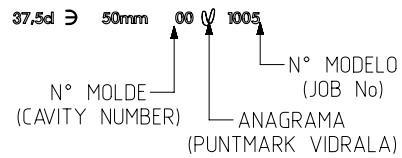
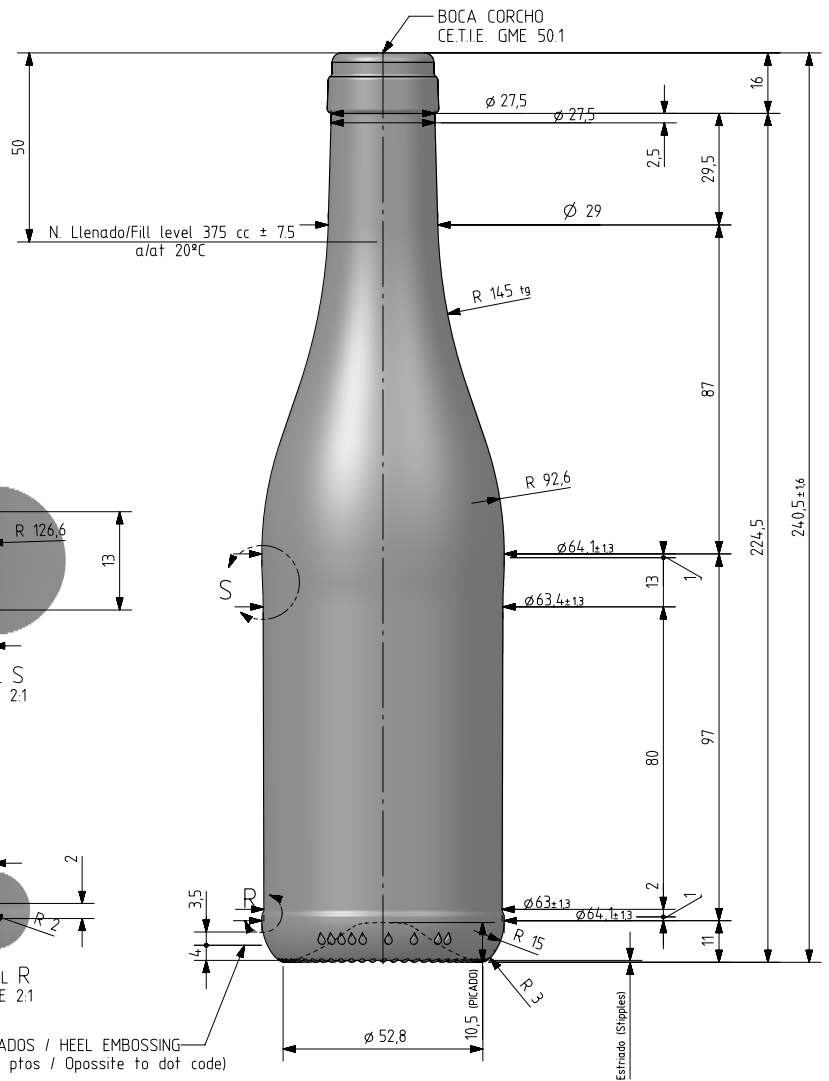

VISTA DEL FONDO
(BOTTOM VIEW)

				Peso aprox / Weight approx	300 gr	 Product Design Office www.vidrala.com
				Capacidad N. llenado / Fillpoint Capacity	375 cc \pm 75 a 50 mm	
				Capacidad a verter / Brimfull Capacity	390 cc \pm aprox	Dibujado / Des. ALR. CAD: 7974-10.prt
10	Eliminada letra de año y pasado a UGS	04-04-19	JAU	Cámara expansión / Vacuity	4,0 % 15 cc	Fecha / Date: 04-04-19 Anula / Annuls: 7974-9
9	Se mod superior etiqueta, z.e. de 72mm a 80mm, cuerpo de ϕ 64,8 a ϕ 64,1	23-07-04	ALR.	Recipiente medida / Meas cap	SI	Escala / Scale: 1:1 N° Plano: 7974-10
8	Se suaviza superior etiqueta, z.e. de de 78mm a 72mm	20-07-04	ALR.	Angulo de volcado / Tilt angle	17,0°	Retornable / Returnable NO 60,6%
Rev	Modificación / Modification	Fecha/Date	Firma/Sign	Carbonatación / Gas vol	0,0 Vol CO2 máx	Modelo: 1005/242 BORGONESA 37,5 cl. ESPECIAL
Este plano es propiedad de Vidrala, no puede ser reproducido ni comunicado sin nuestro permiso. Las cotas no toleradas son aproximadas. Specification agreements are based on tolerated dimensions only. Do not scale drawing, copyright reserved. Not to be copied in whole or part without written permission from vidrala. All dimensions are in millimeters.				Presión larga duración / Long Term pressure: 0 Bar Max	Páster: NO	
				Resistencia. choque térmico / Thermal Shock Max:	42 °C	